

Grab Bar Modern Cast Zinc+Steel
Design Backings Composition



www.sydneybathaccessories.com

Sydney installation instructions

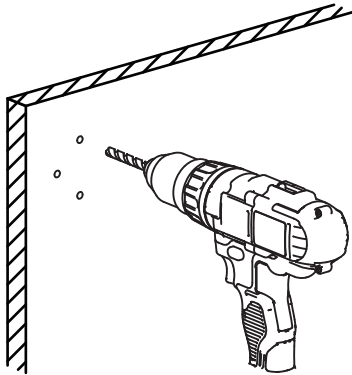

Figure 1.
Mark (on the wall) locations of plugs through mounting plate using a pencil, drill 3/16" holes, make sure to keep drill level.

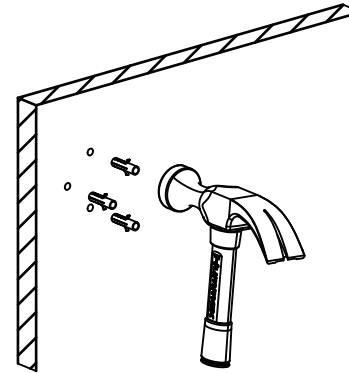

Figure 2.
Insert plugs into drilled holes, using a hammer to tap the plugs in, be careful not to break tile.

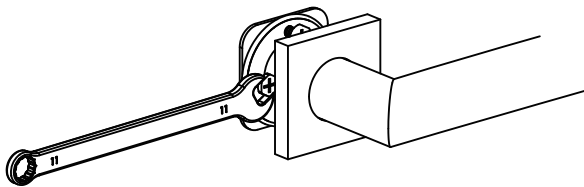

Figure 3.
Driver bolt nut directly into holes.

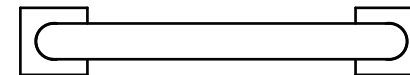

Figure 4.
Tighten the cover on the Mounting plate

Grab Bar Modern Cast Zinc+Steel
Design Backings Composition



www.sydneybathaccessories.com

Sydney installation instructions

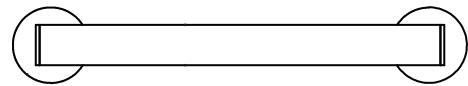
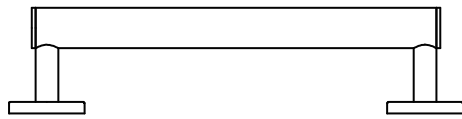

SYD-GB1

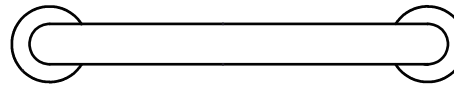
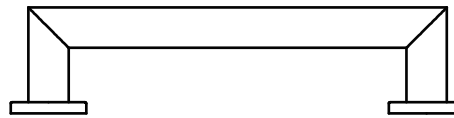

SYD-GB2

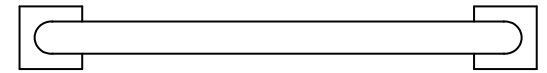
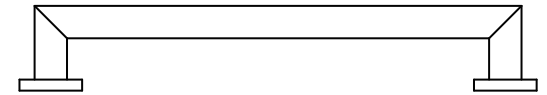

SYD-GB3

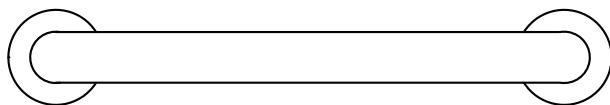
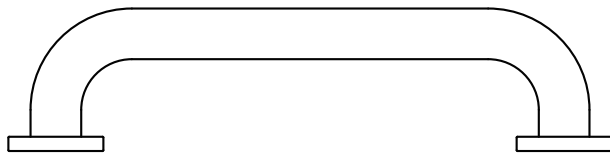

SYD-GB4

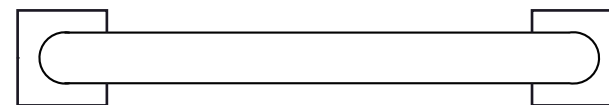
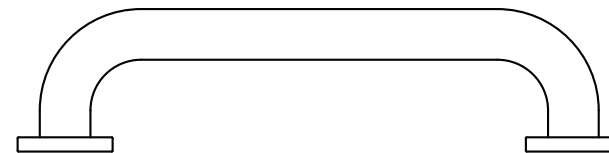

SYD-GB5